

# OUTLINE DIMENSIONAL DRAWING

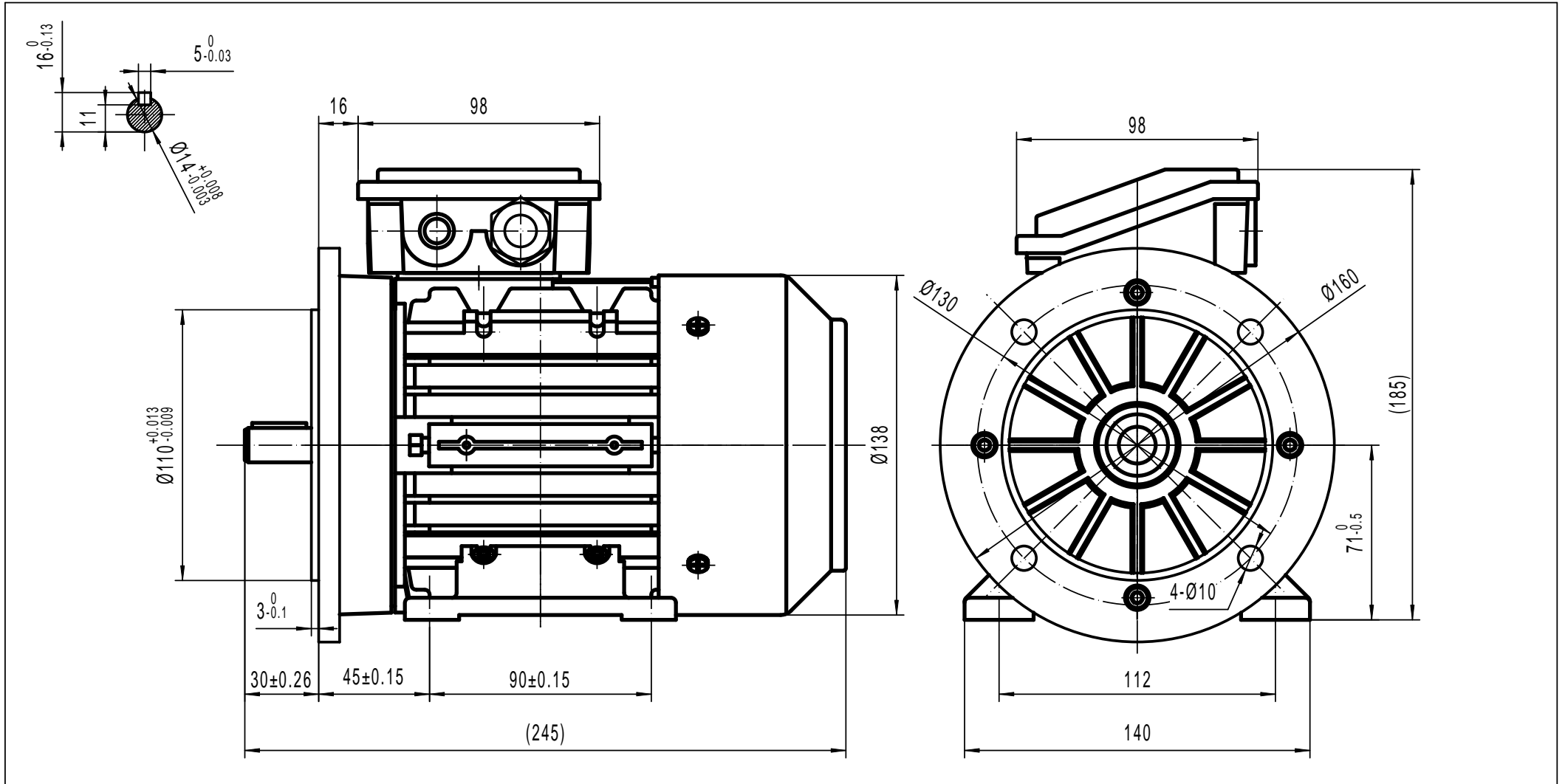

|                           |                      |
|---------------------------|----------------------|
| TECHTOP AUSTRALIA PTY LTD |                      |
| FRAME                     | TAI 71A B35          |
| DATE                      | DRAWING NO.          |
| 2011/10/14                | 1ST082.051.001-010 A |